

# 90068

FLORA

v2

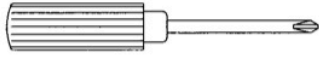

|             |             |             |             |  |
|-------------|-------------|-------------|-------------|--|
| CA<br>4<br> | DA<br>4<br> | QL<br>1<br> | SB<br>1<br> |  |
| VJ<br>8<br> | VA<br>2<br> | VZ<br>6<br> | QG<br>1<br> |  |

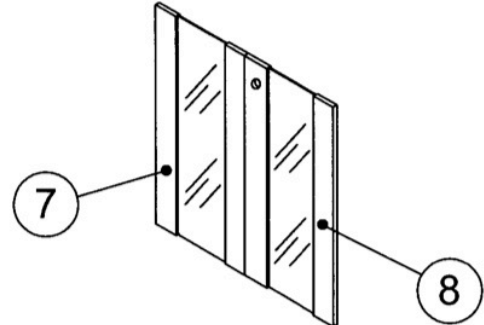

1

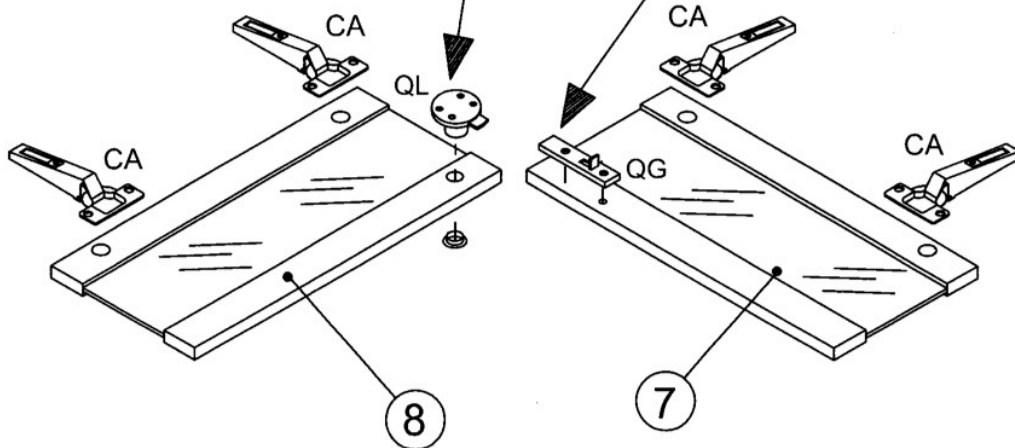
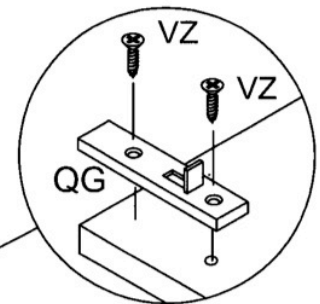
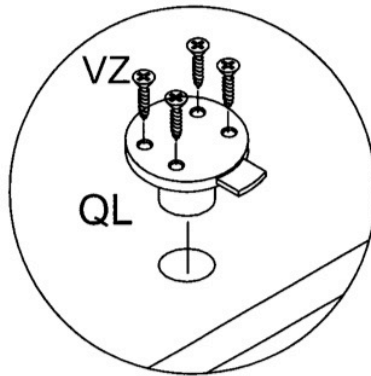
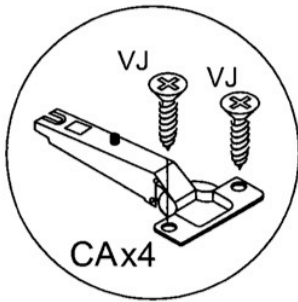

2

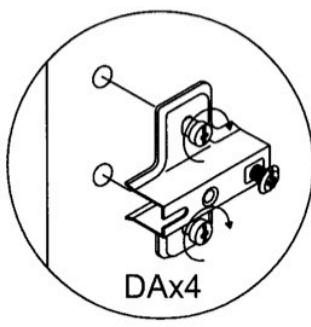
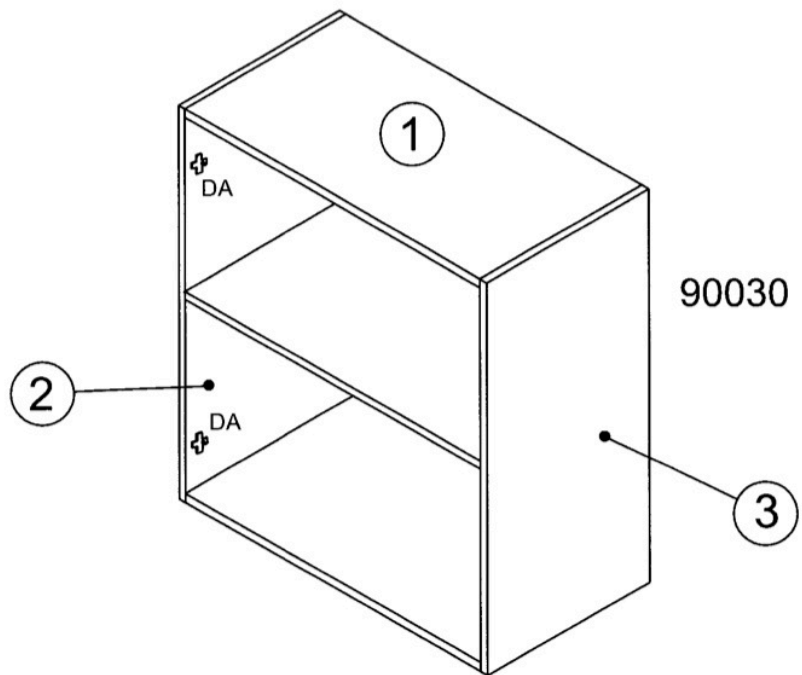

3

