

# BMNG

15175

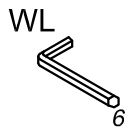

1

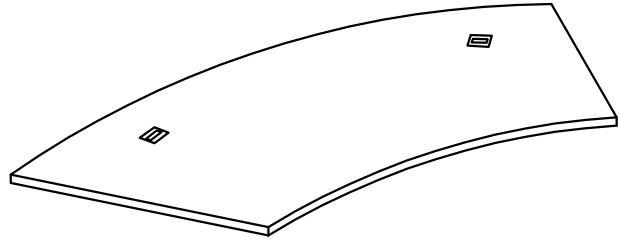
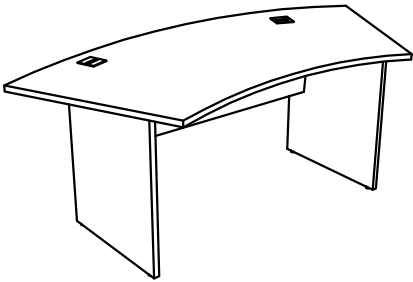
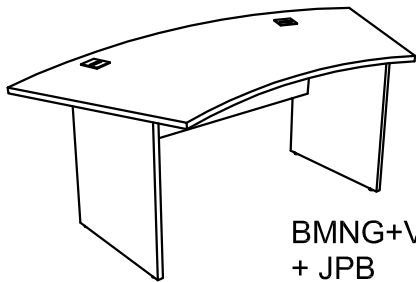

BMNG+VB14  
+ JPB

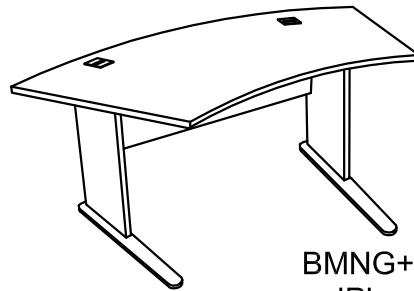

BMNG+VB14  
+ JPL

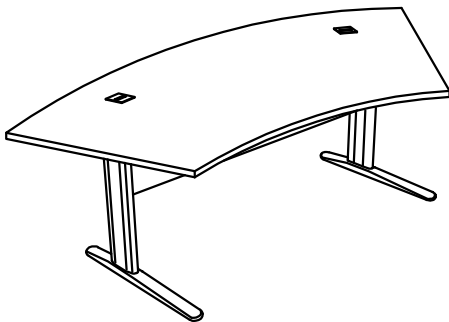

BMNG+VB14  
+ Pieds metal L

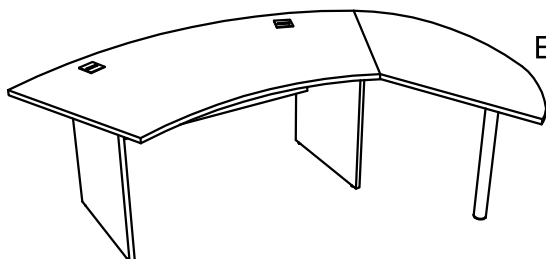
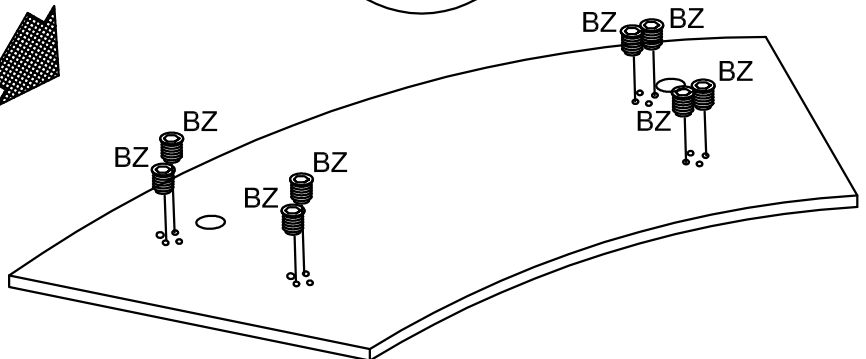
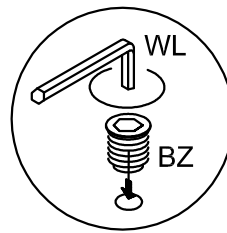

EXTC

# EXTC

15175

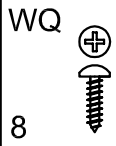
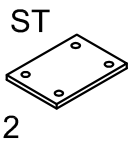
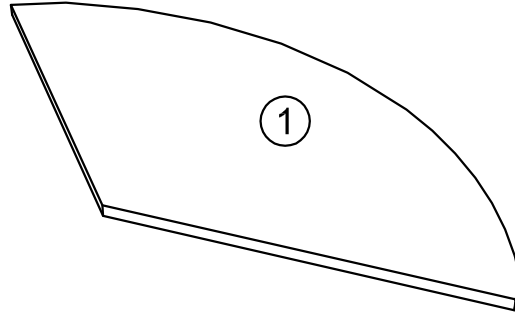
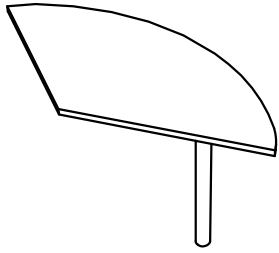

**1**

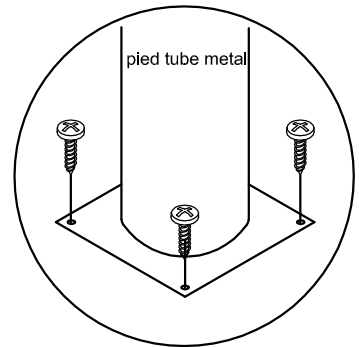
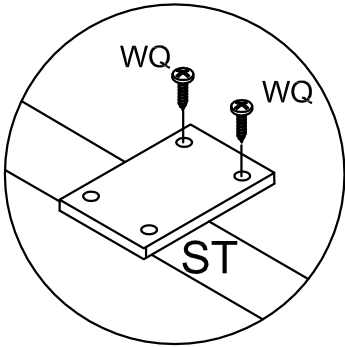
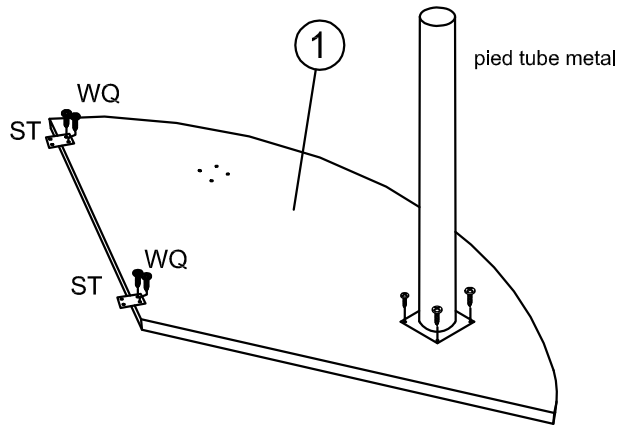

EXTC

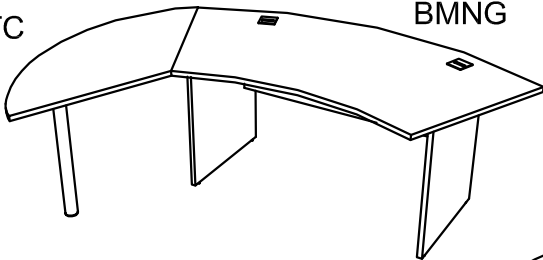

BMNG

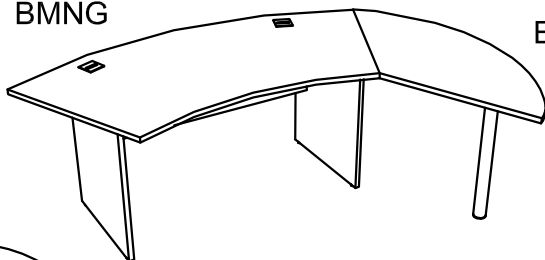

EXTC

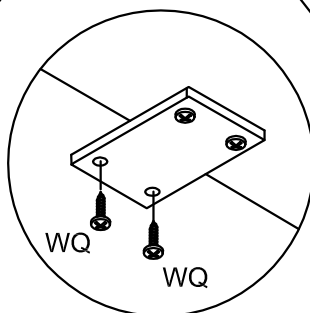

# CA80

15196

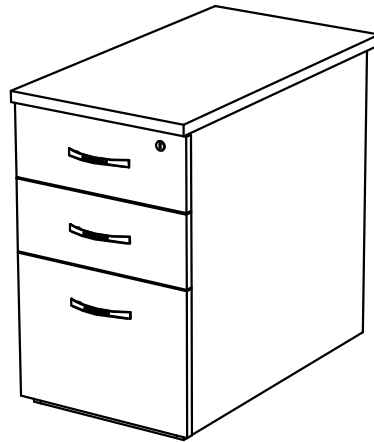
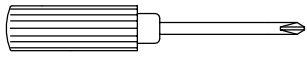

PE



4

LE



3

NA



6

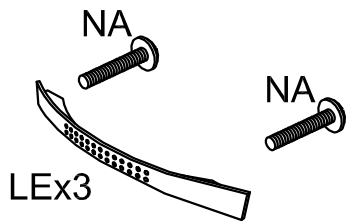

PEx4

