

# SL 608

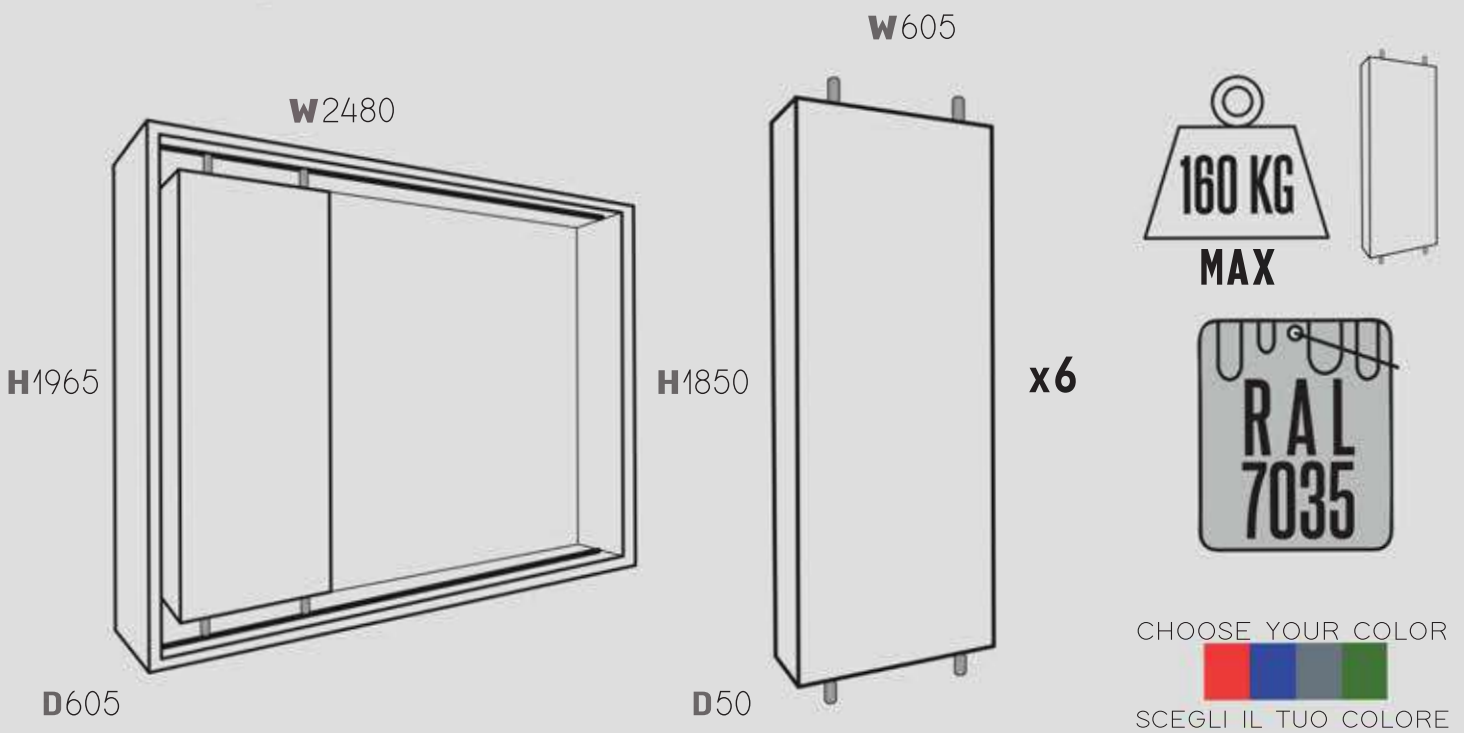

\* venduto smontato | sold disassembled

\* singolo prodotto: mm - venduto singolarmente | measures: mm - sold individually

# KIT STANDARD

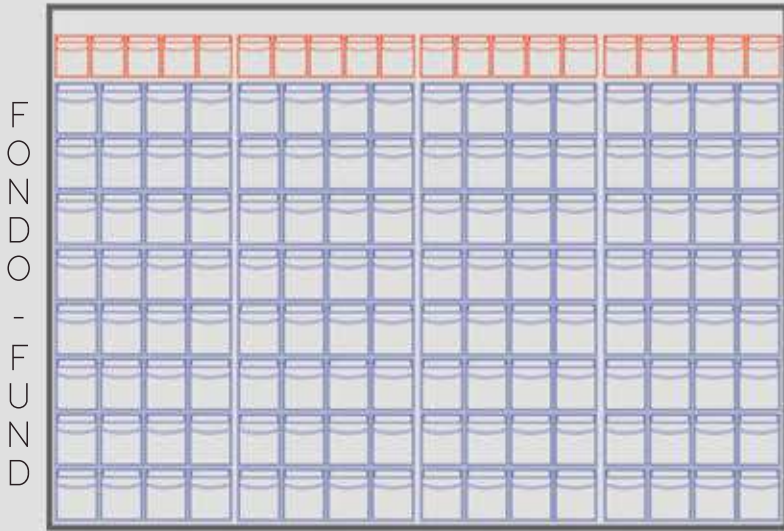

F  
O  
Z  
D  
F  
-  
O  
D  
D  
F  
-  
O  
D  
D  
F  
-  
O  
D  
D  
F

**MB5**  
**x4** P  
A  
N  
E  
L  
S  
  
**MB4**  
**x32**

cassetti | drawers = 601 TOT

x3

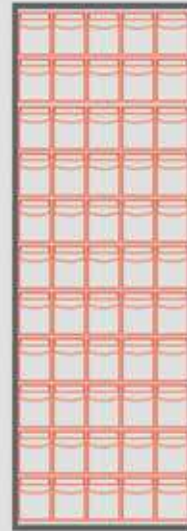

x3

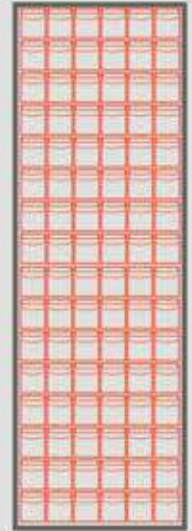

**MB5**  
**x11**

**MB6**  
**x16**



# KIT - A

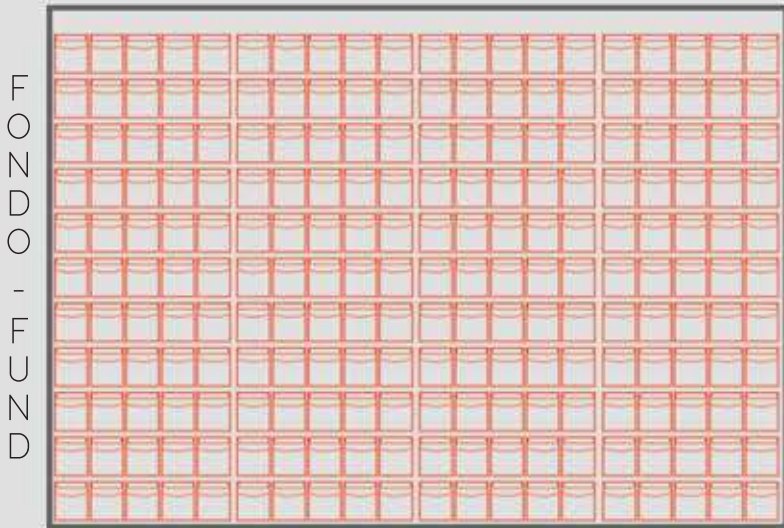

F  
O  
Z  
D  
F  
-  
O  
D  
D  
F  
-  
O  
D  
D  
F  
-  
O  
D  
D  
F

**MB5**  
**x44** P  
A  
N  
E  
L  
S

cassetti | drawers = 673 TOT

x3

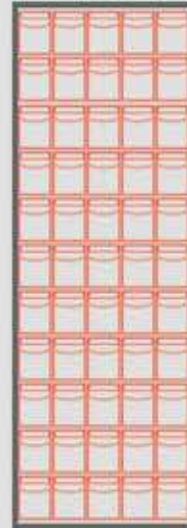

x3



**MB5**  
**x11**

**MB6**  
**x16**

# KIT - B

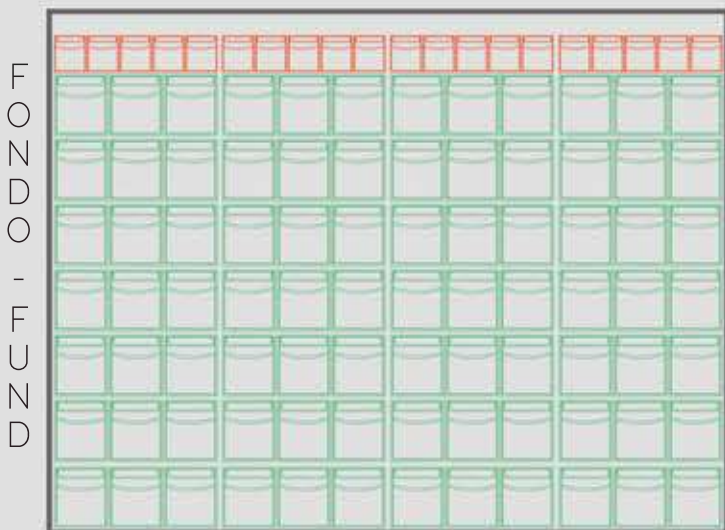

F  
O  
Z  
D  
F  
-  
O  
D  
D  
F  
-  
O  
D  
D  
F  
-  
O  
D  
D  
F

**MB5**  
**x4** P  
A  
N  
E  
L  
S

**MB3**  
**x28**

cassetti | drawers = 503 TOT

x3



x3

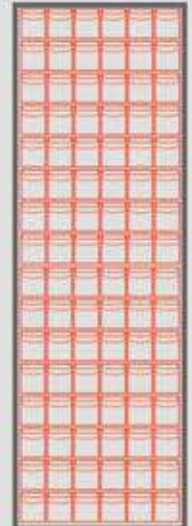

**MB5**  
**x1**

**MB4**  
**x8**

**MB6**  
**x16**

