

SL 609

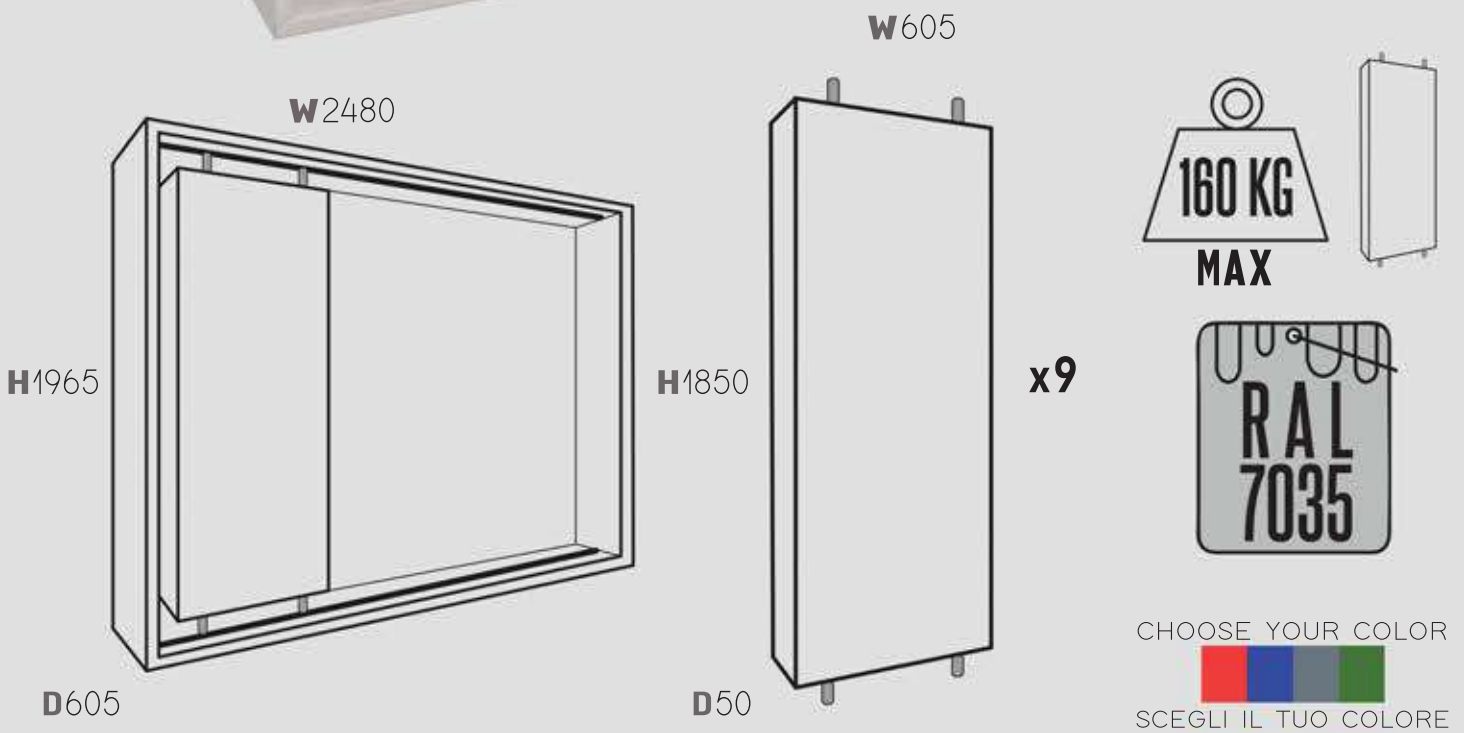

\* venduto smontato | sold disassembled

\* singolo prodotto: mm - venduto singolarmente | measures: mm - sold individually

# KIT STANDARD

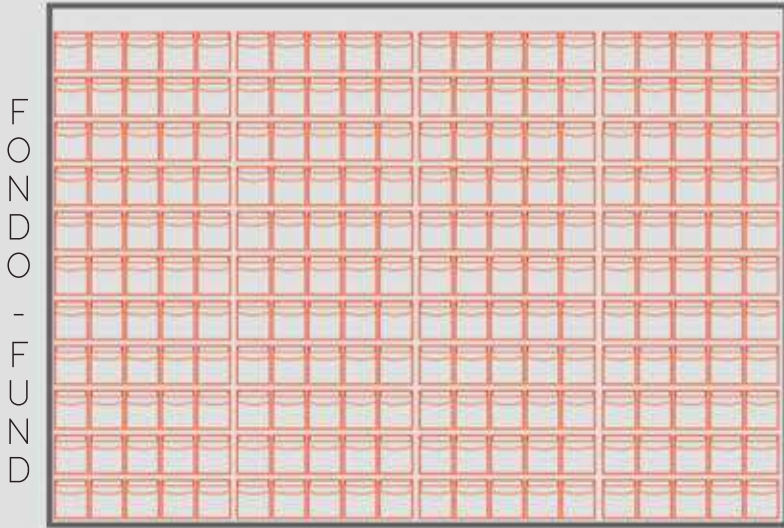

**MB5  
x44**

cassetti | drawers = 1084 TOT



**x9**

P  
A  
N  
E  
L  
S

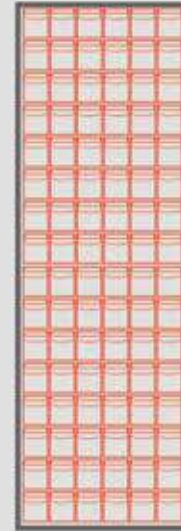

**MB6  
x16**



# KIT - A

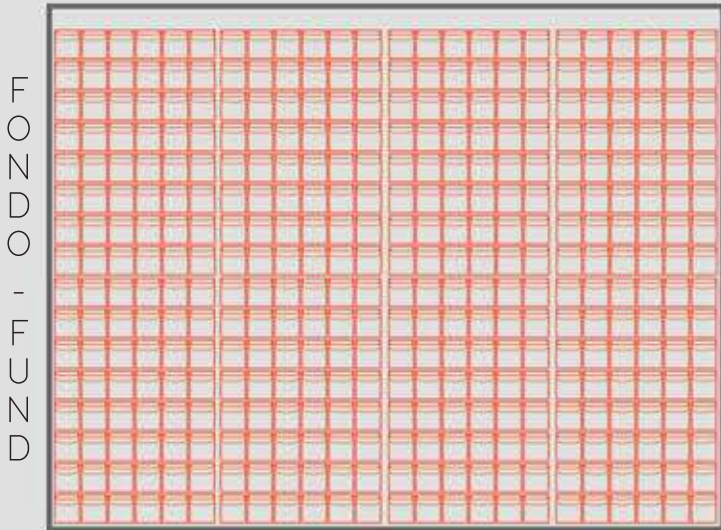

**MB6  
x64**

cassetti | drawers = 1248 TOT

**x9**

P  
A  
N  
E  
L  
S

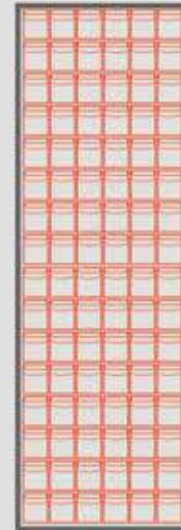

**MB6  
x16**

# KIT - B

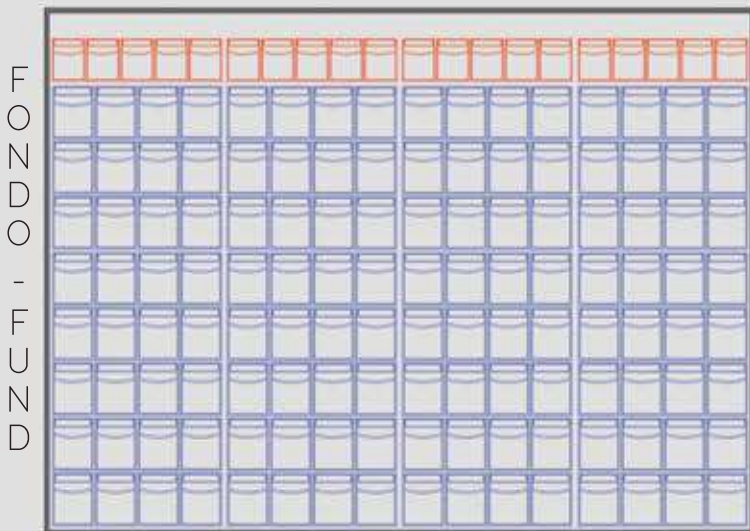

**MB5  
x4**

**MB4  
x32**

cassetti | drawers = 1012 TOT



**x9**

P  
A  
N  
E  
L  
S

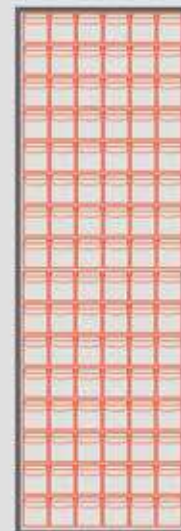

**MB6  
x16**